

# ST. PATRICKS DAY WORKSHEET FOR KIDS

NAME: \_\_\_\_\_

CLASS: \_\_\_\_\_

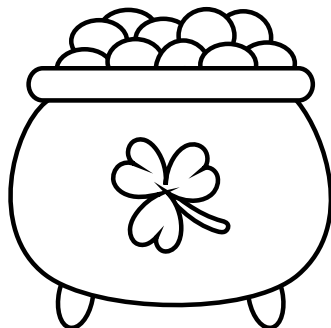
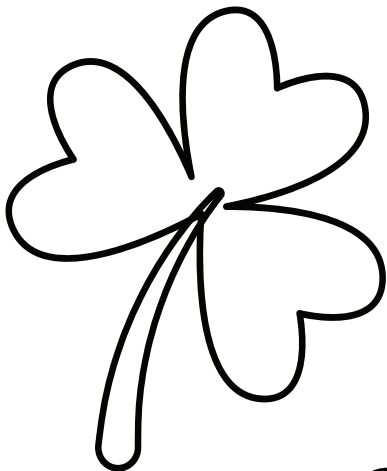

Name \_\_\_\_\_

Date \_\_\_\_\_

# Write The Missing Letter

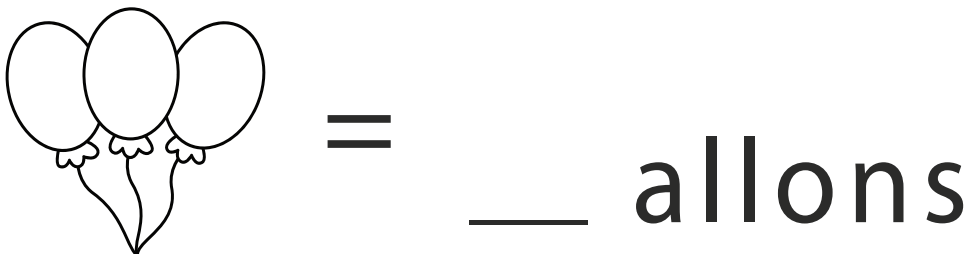
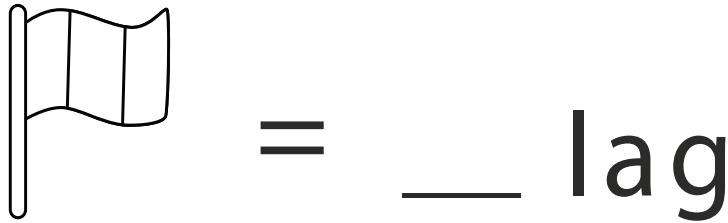
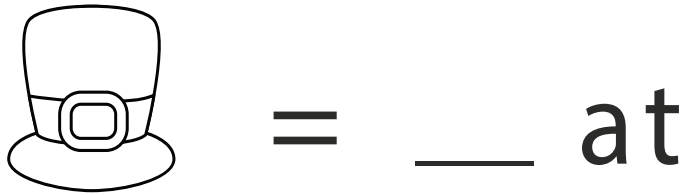
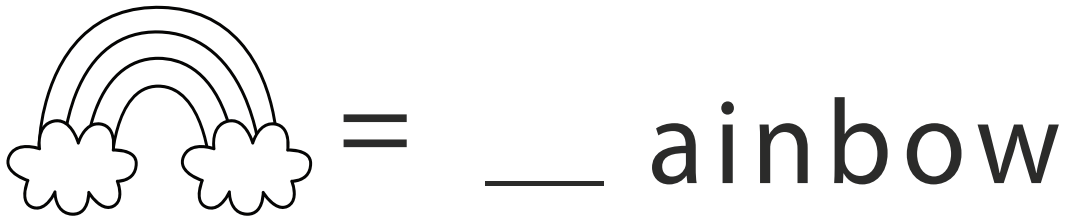

Name \_\_\_\_\_

Date \_\_\_\_\_

# St. Patrick's Day Maze 1

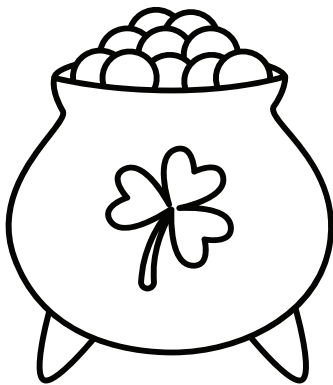
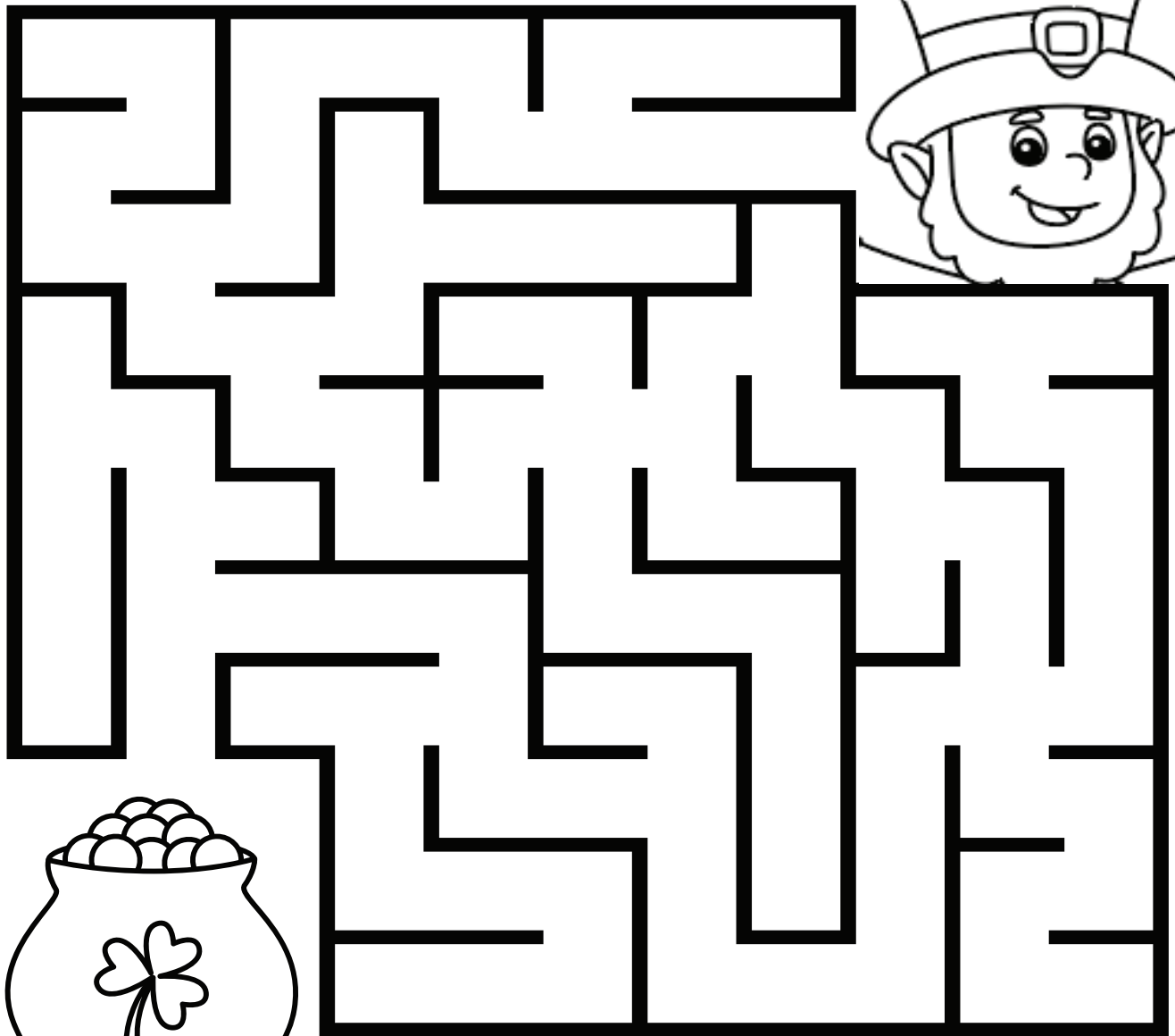

Name \_\_\_\_\_

Date \_\_\_\_\_

# St. Patricks Day Maze 2

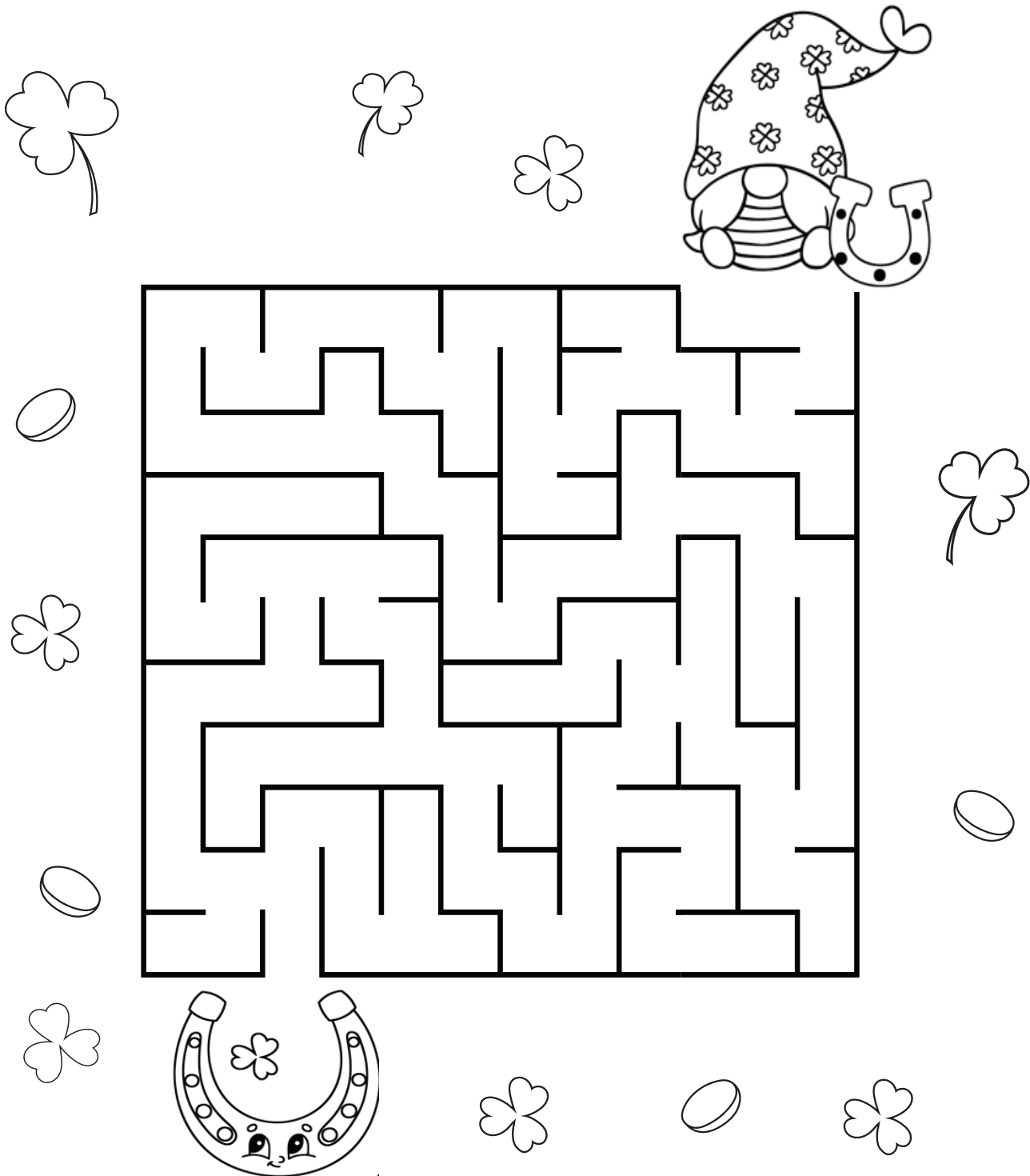

Name \_\_\_\_\_

Date \_\_\_\_\_

# St. Patrick's Day Math Maze

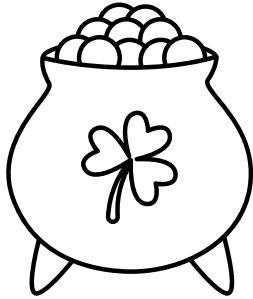

		1	2	4	6	7
		↓	5	0	9	8
3	2	1	0	3	9	0
4	5	6	5	10	7	6
7	6	8	12	10	12	10
8	7	9	13	14	15	17
9	10	11	16	16	18	19
13	15	12	15	16		
19	16	13	14	→		

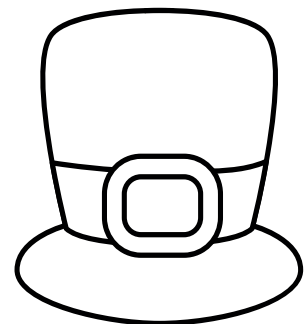



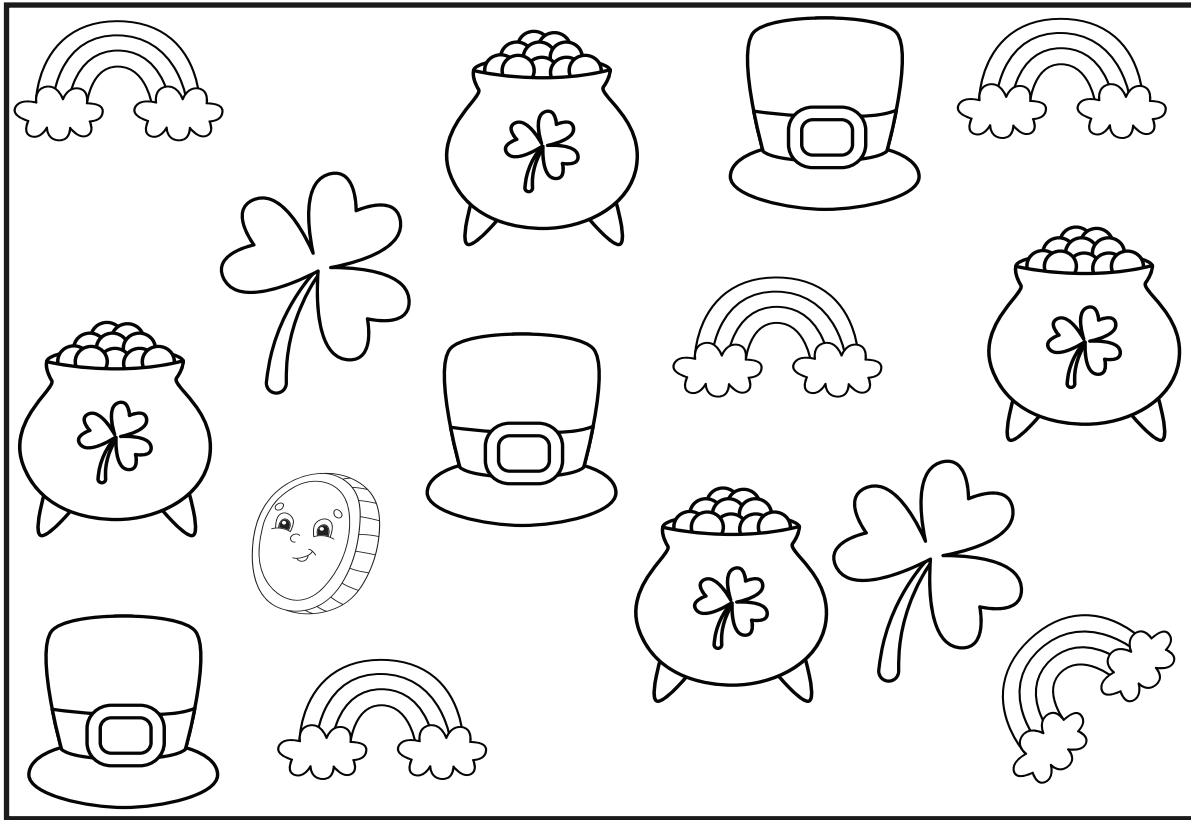

Name \_\_\_\_\_

Date \_\_\_\_\_

# Count and Graph



					
1					
2					
3					
4					
5					

Name \_\_\_\_\_

Date \_\_\_\_\_

# St. Patricks Day Maze 3

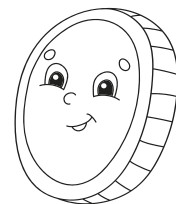
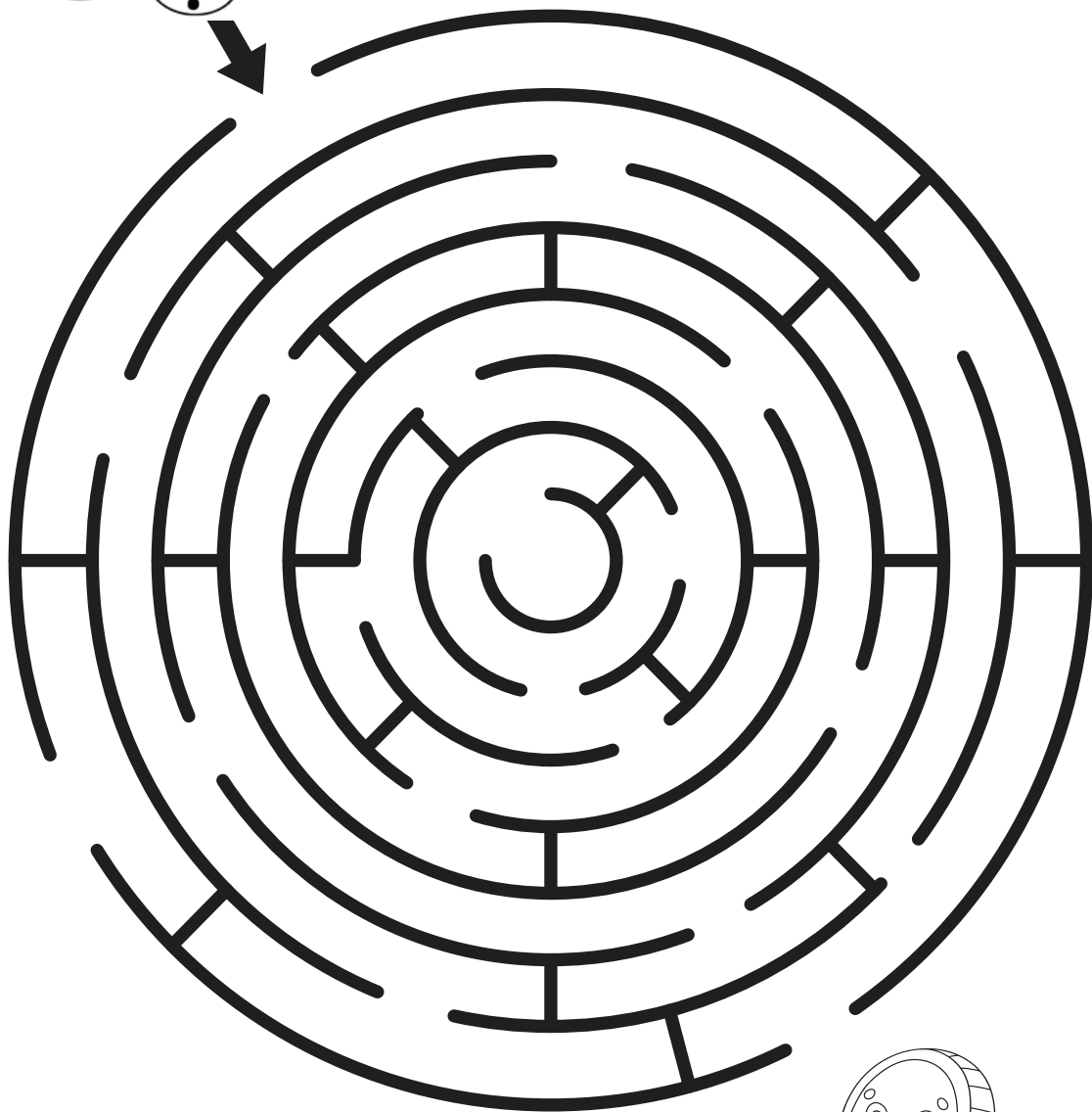
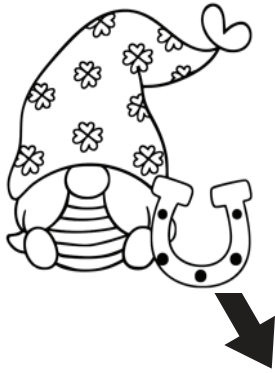

Name \_\_\_\_\_

Date \_\_\_\_\_

# Subtraction

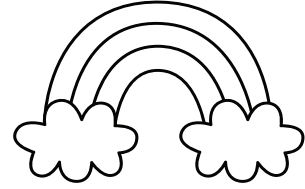
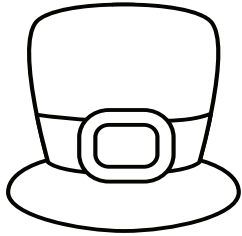

$4 - 2 = \square$

$2 - 2 = \square$

$8 - 1 = \square$

$5 - 2 = \square$

$5 - 5 = \square$

$5 - 0 = \square$

$5 - 1 = \square$

$7 - 1 = \square$

$3 - 2 = \square$

$5 - 2 = \square$

$8 - 3 = \square$

$7 - 2 = \square$



Name \_\_\_\_\_

Date \_\_\_\_\_

# St. Patricks Day Maze 4

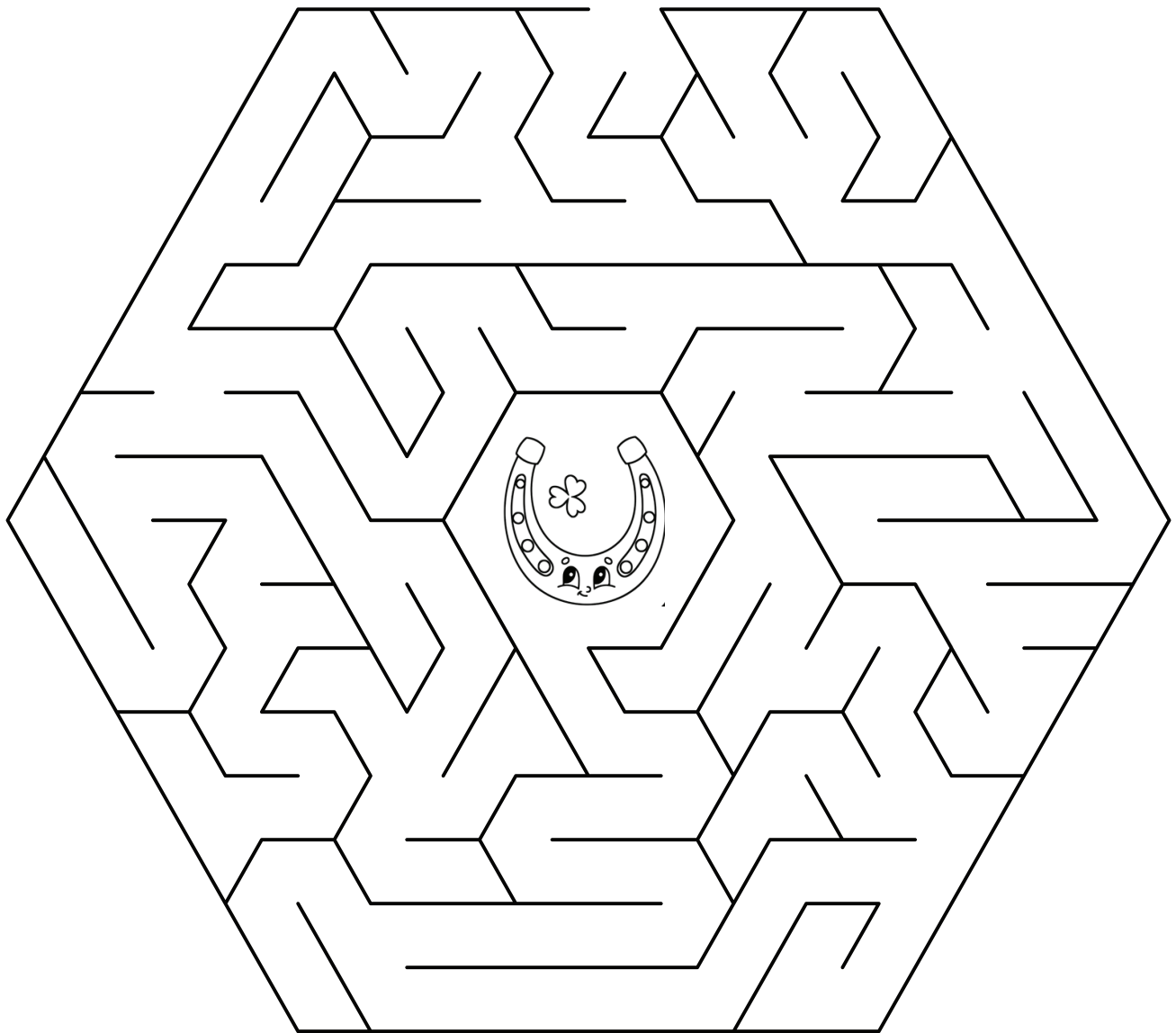
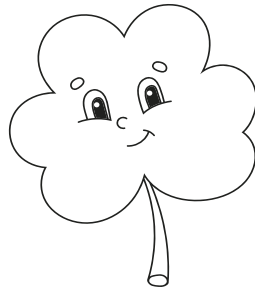

Name \_\_\_\_\_

Date \_\_\_\_\_

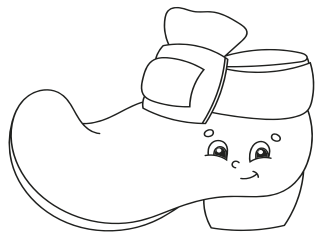

# Addition

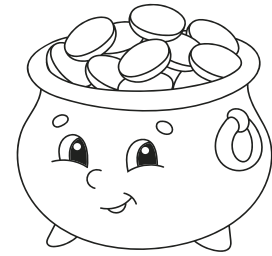

$4 + 6 = \square$

$3 + 6 = \square$

$6 + 3 = \square$

$0 + 6 = \square$

$3 + 2 = \square$

$5 + 2 = \square$

$3 + 5 = \square$

$3 + 4 = \square$

$4 + 7 = \square$

$7 + 1 = \square$

$1 + 0 = \square$

$4 + 3 = \square$

Name \_\_\_\_\_

Date \_\_\_\_\_

# Subtraction

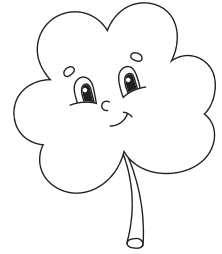

$10 - 2 = \square$

$7 - 3 = \square$

$4 - 4 = \square$

$6 - 5 = \square$

$8 - 3 = \square$

$10 - 7 = \square$

$3 - 0 = \square$

$4 - 1 = \square$

$9 - 1 = \square$

$5 - 2 = \square$

$10 - 5 = \square$

$7 - 6 = \square$

Name \_\_\_\_\_

Date \_\_\_\_\_

# Addition

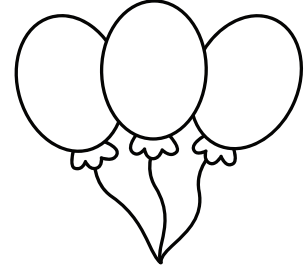
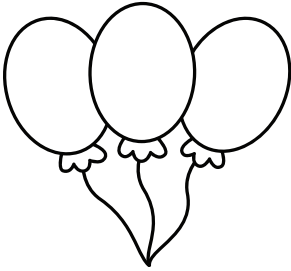

$2 + 1 = \square$

$5 + 7 = \square$

$3 + 7 = \square$

$1 + 5 = \square$

$8 + 2 = \square$

$7 + 4 = \square$

$5 + 1 = \square$

$0 + 2 = \square$

$3 + 5 = \square$

$0 + 6 = \square$

$2 + 4 = \square$

$6 + 3 = \square$

Name \_\_\_\_\_

Date \_\_\_\_\_

# Addition

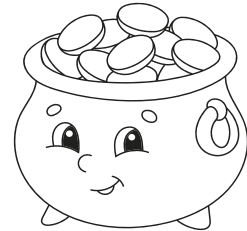
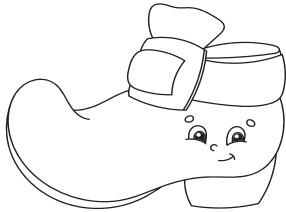

$3 + 6 = \square$

$2 + 3 = \square$

$2 + 6 = \square$

$0 + 6 = \square$

$3 + 4 = \square$

$3 + 6 = \square$

$5 + 1 = \square$

$5 + 4 = \square$

$3 + 7 = \square$

$4 + 1 = \square$

$4 + 0 = \square$

$7 + 3 = \square$

Name \_\_\_\_\_

Date \_\_\_\_\_

# Addition and Subtraction

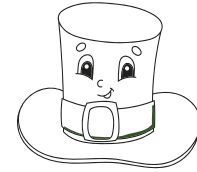
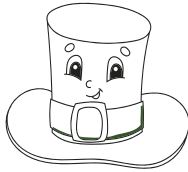

2	+	3	=	
4	-	1	=	
3	+	8	=	
6	-	5	=	
5	+	10	=	

15   1   11   3   5

Name \_\_\_\_\_

Date \_\_\_\_\_

# Addition

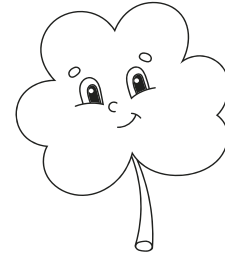
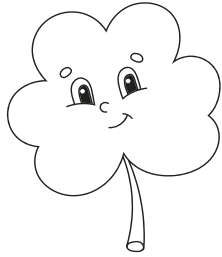

$6 + 3 = \square$

$1 + 9 = \square$

$7 + 0 = \square$

$3 + 5 = \square$

$0 + 3 = \square$

$3 + 3 = \square$

$2 + 4 = \square$

$5 + 5 = \square$

$2 + 6 = \square$

$1 + 7 = \square$

$6 + 4 = \square$

$4 + 4 = \square$

Name \_\_\_\_\_

Date \_\_\_\_\_

# Word Search

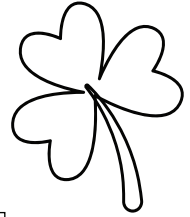

O	Q	N	O	T	A	N	J	K	P
N	V	O	X	M	S	Q	O	Y	Y
G	M	X	J	A	H	C	K	R	R
G	S	Q	M	R	A	S	A	X	A
A	O	Y	E	C	M	I	R	W	I
M	M	L	X	H	R	H	G	Q	N
M	U	O	D	A	O	A	R	K	B
U	Z	M	Z	W	C	T	E	L	O
T	S	Y	M	D	K	Q	E	D	W
T	G	F	G	P	N	E	N	B	O

**RAINBOW**

**SHAMROCK**

**MARCH**

**GREEN**

**GOLD**

**HAT**

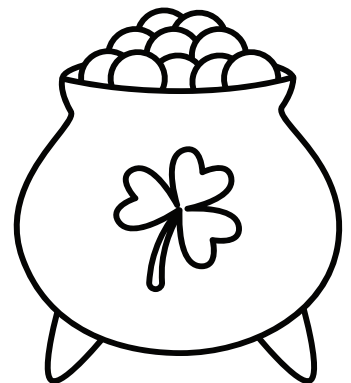



Name \_\_\_\_\_

Date \_\_\_\_\_

# Word Scramble

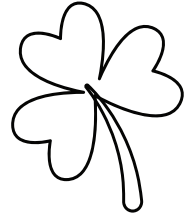
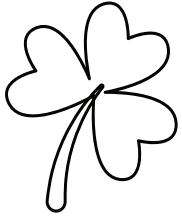

iabrwno

\_\_\_\_\_

cmhra

\_\_\_\_\_

ogdl

\_\_\_\_\_

okmrcash

\_\_\_\_\_

gnere

\_\_\_\_\_

ath

\_\_\_\_\_

kcul

\_\_\_\_\_

arnlpceeuh

\_\_\_\_\_

cvoerl

\_\_\_\_\_

Ideairn

\_\_\_\_\_

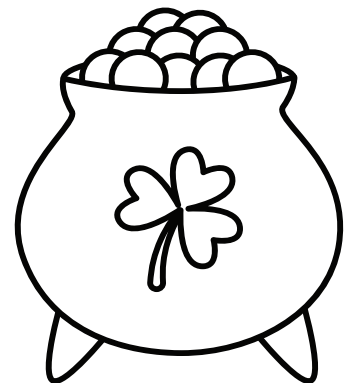

Name \_\_\_\_\_

Date \_\_\_\_\_

# St. Patrick's Day Dot To Dot

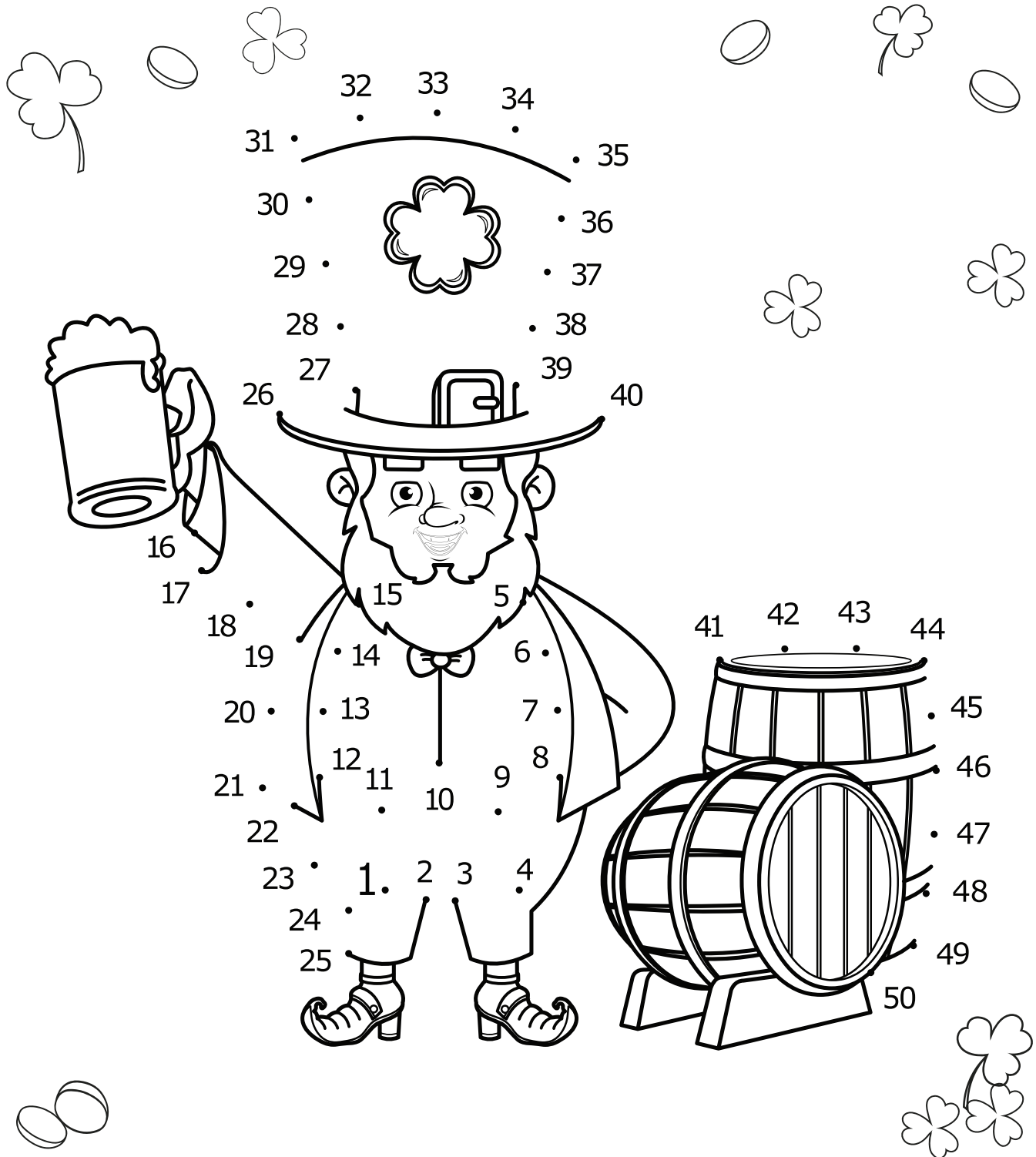

Name \_\_\_\_\_

Date \_\_\_\_\_

# St. Patricks Day Dot To Dot

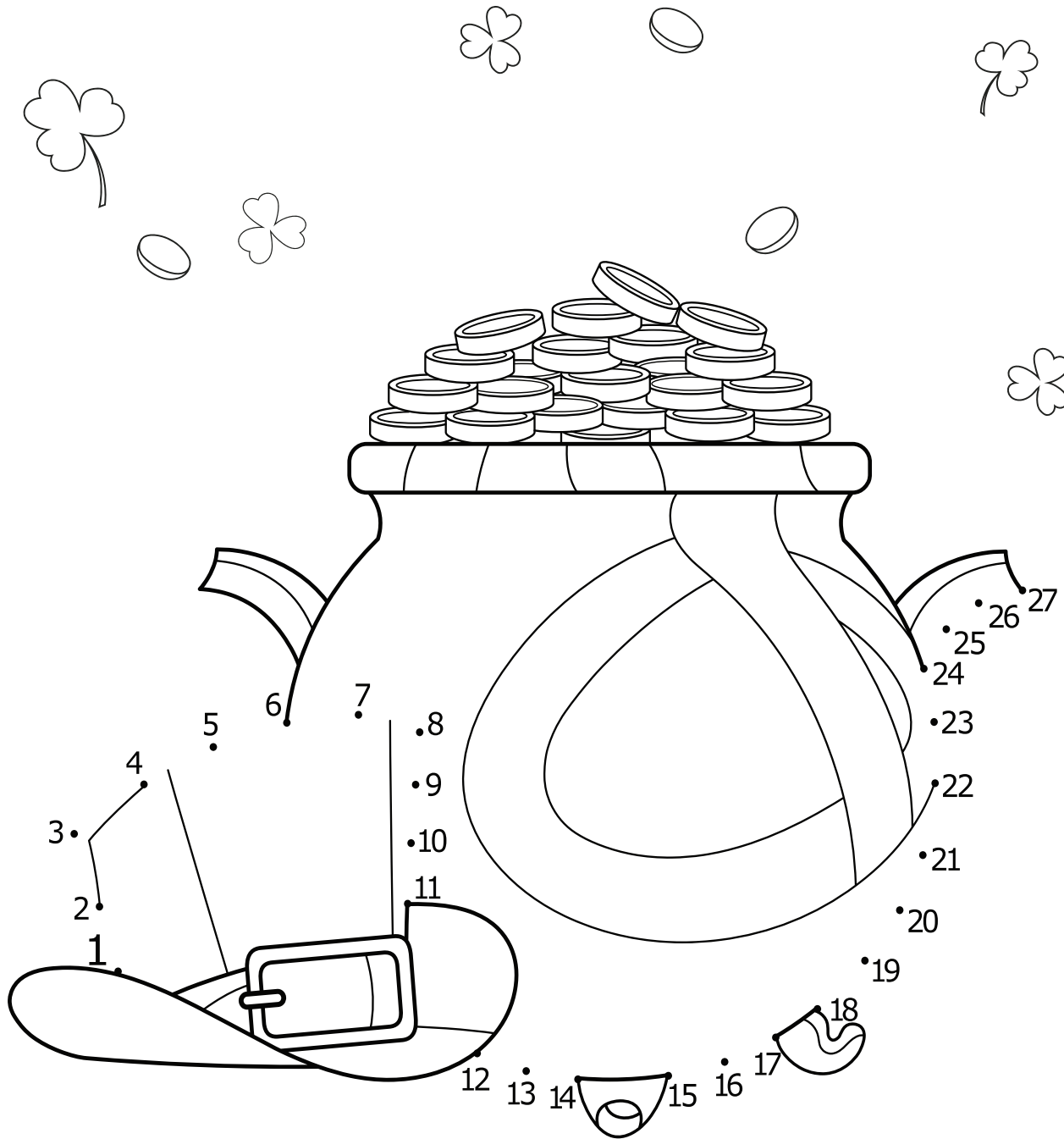

Name \_\_\_\_\_

Date \_\_\_\_\_

# St. Patrick's Day Dot Marker



Name \_\_\_\_\_

Date \_\_\_\_\_

# Color By Number

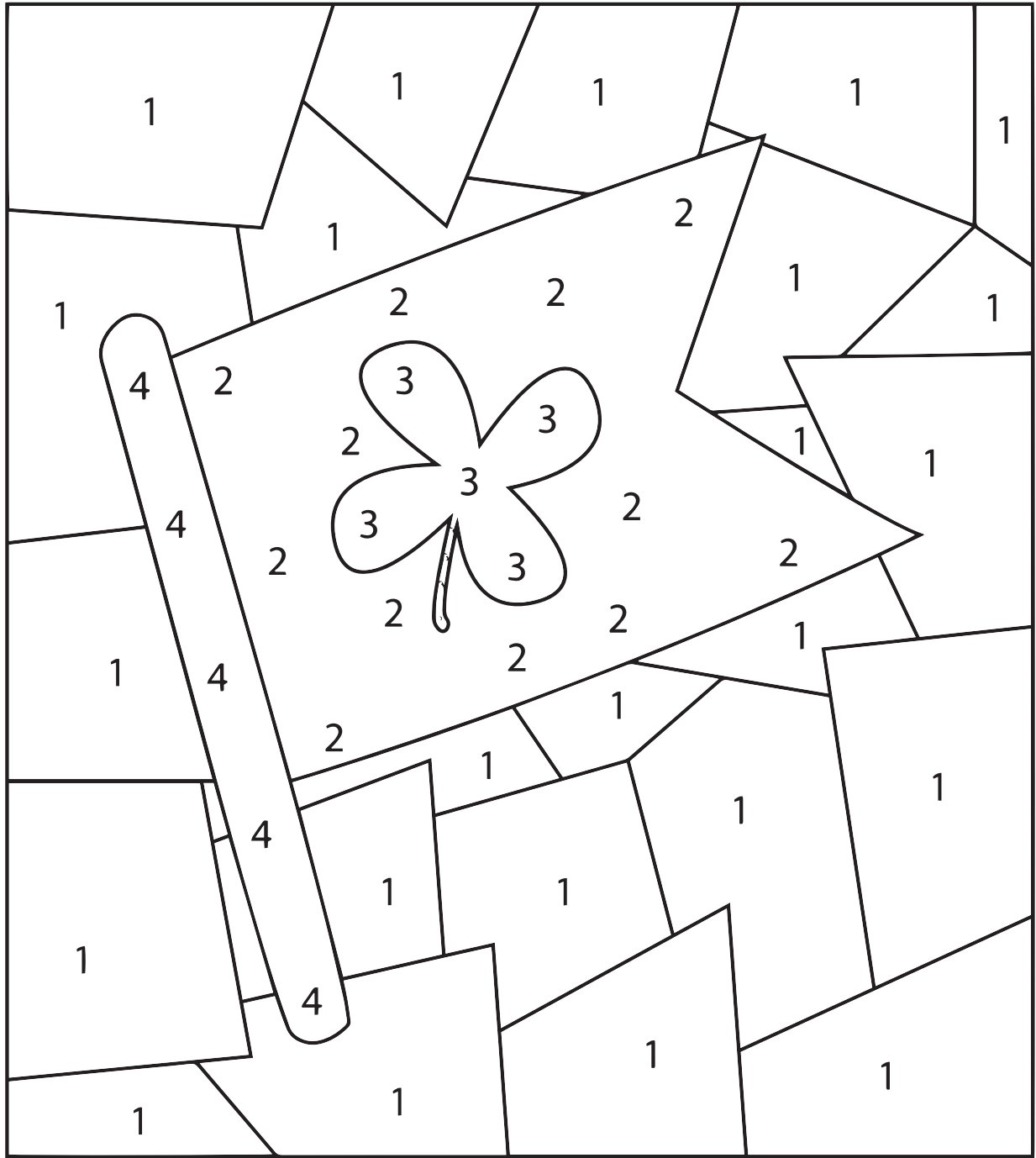

1. Pink 2. Green 3. Sunflower 4. Pastel Brown

Name \_\_\_\_\_

Date \_\_\_\_\_

# Coloring Page



Name \_\_\_\_\_

Date \_\_\_\_\_

# I Am Lucky Becuase...

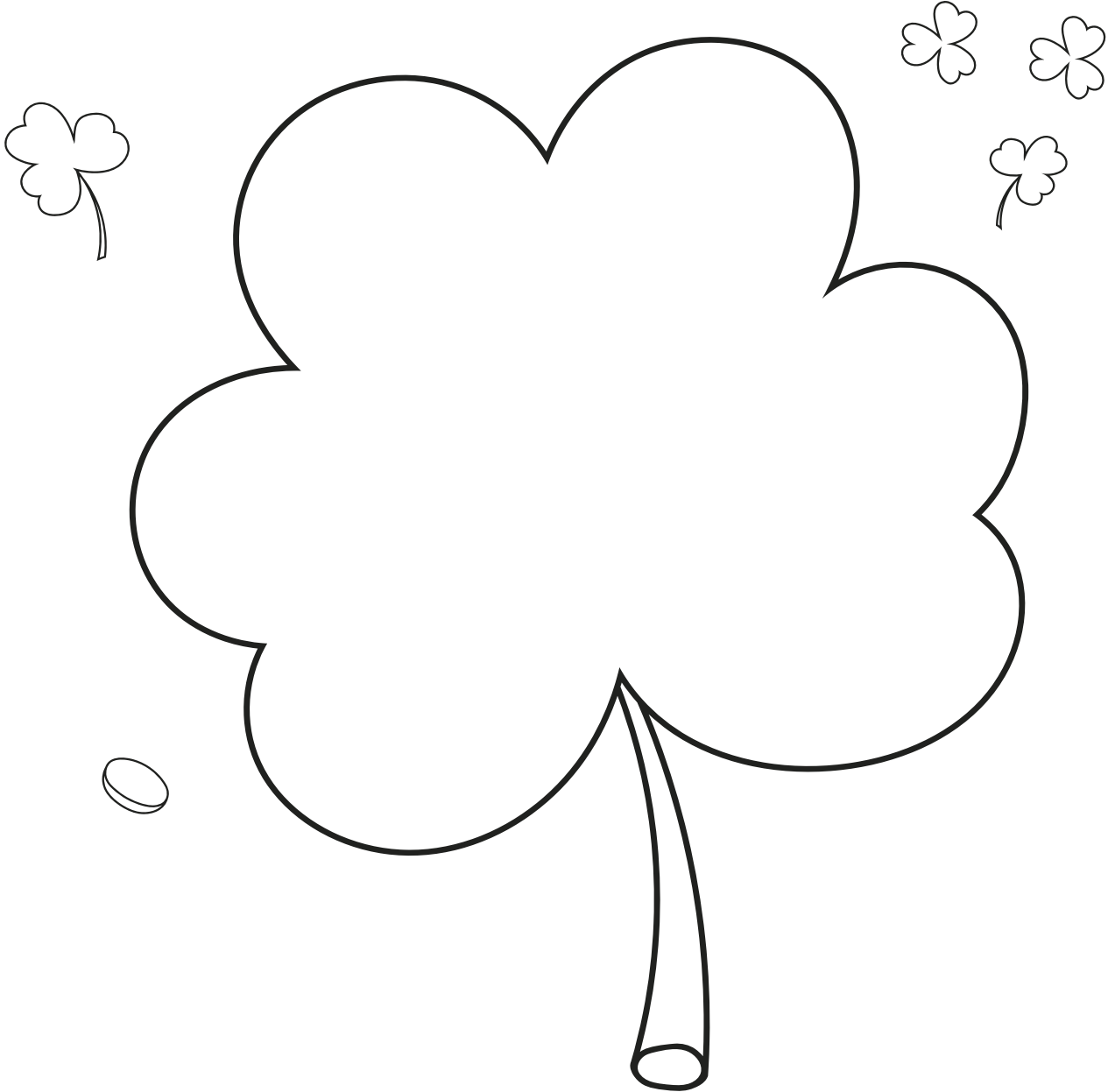

---

---

---

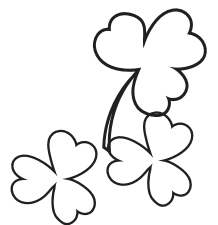

Name \_\_\_\_\_

Date \_\_\_\_\_

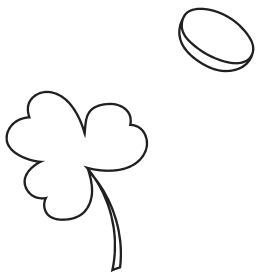

# How To Catch A Leprechaun?

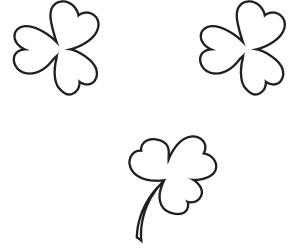

---

---

---

---

---

---

---

---

---

---

---

---

---

---

---

---

Written By: \_\_\_\_\_

